

Acer Monitor V226HQL

LIFECYCLE EXTENSION GUIDE

Contents

Table of Contents

Important Safety Notice	3
1. Exploded Diagram	4
2. Wiring connectivity diagram	5
3. Mechanical Instruction	7
4. Disassembly and Assembly SOP	8
5. Troubleshooting	12
6. FRU List	14

Safety Notice

Any person attempting to service this chassis must familiarize with the chassis and be aware of the necessary safety precautions to be used when serving electronic equipment containing high voltage

Important Safety Notice

Product Announcement:

This product is certificated to meet RoHS Directive and Lead-Free produced definition. Using approved critical components only is recommended when the situation to replace defective parts. Vender assumes no liability express or implied, arising out of any unauthorized modification of design or replacing non-RoHS parts. Service providers assume all liability.

Qualified Repairability:

Proper service and repair is important to the safe, reliable operation of all series products. The service providers recommended by vender should being aware of notices listed in this service manual in order to minimize the risk of personal injury when perform service procedures. Furthermore, the possible existed improper repairing method may damage equipment or products. It is recommended that service engineers should have repairing knowledge, experience, as well as appropriate product training per new model before performing the service procedures.

NOTICE:

! To avoid electrical shocks, the products should be connect to an authorized power cord, and turn off the master power switch each time before removing the AC power cord.

! To prevent the product away from water or explosed in extremely high humility environment.

! To ensure the continued reliability of this product, use only original manufacturer's specified parts.

! To ensure following safety repairing behavior, put the replaced part on the components side of PWBA, not solder side.

! To ensure using a proper screwdriver, follow the torque and force listed in assembly and disassembly procedures to screw and unscrew screws.

! Using Lead-Free solder to well mounted the parts.

! The fusion point of Lead-Free solder requested in the degree of 220°C.

1. Exploded Diagram

1.1 Product Exploded Diagram

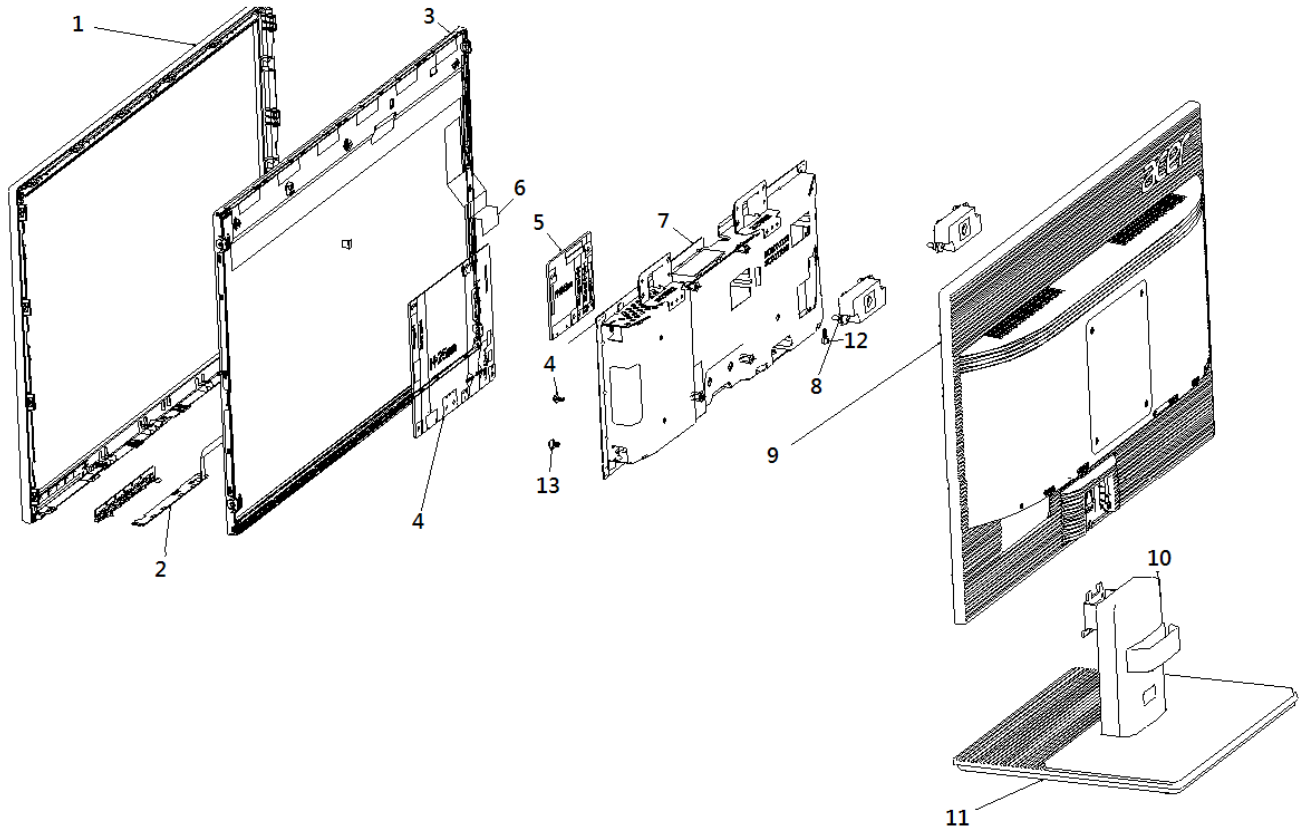

Item	ODM DESCRIPTION
1	ASSY BZL
2	PCBA CTRL
3	LCDM
4	PCB SPS BD
5	PCB IF BD
6	FFC LVDS
7	ASSY SHD
8	SPK
9	ASSY RC
10	ASSY CLMN
11	ASSY BASE
12-13	SCRW

2. Wiring connectivity diagram

There are four types of wiring diagrams for model V226HQL. The wiring connectivity position will be different according to the ACTUAL PCBA connector position. Please base on different SKU refer to below diagram.

NOTE: INF BD= Interface Board, PWR BD=Power Board, CTRL BD= Control Board

1. SKU without USB, without HDMI/DP

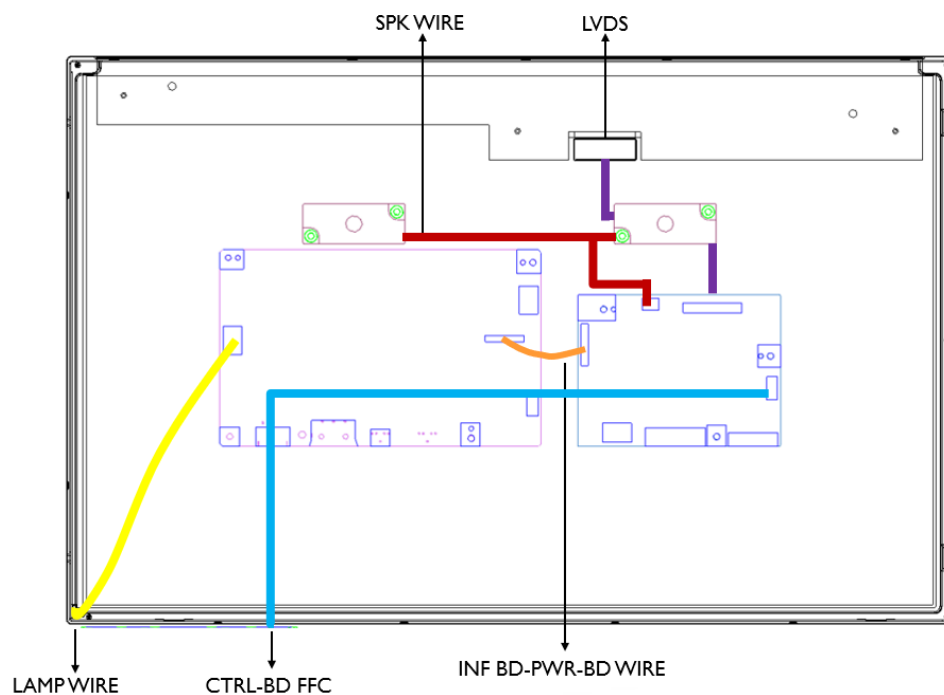

2. SKU without USB, with HDMI/DP

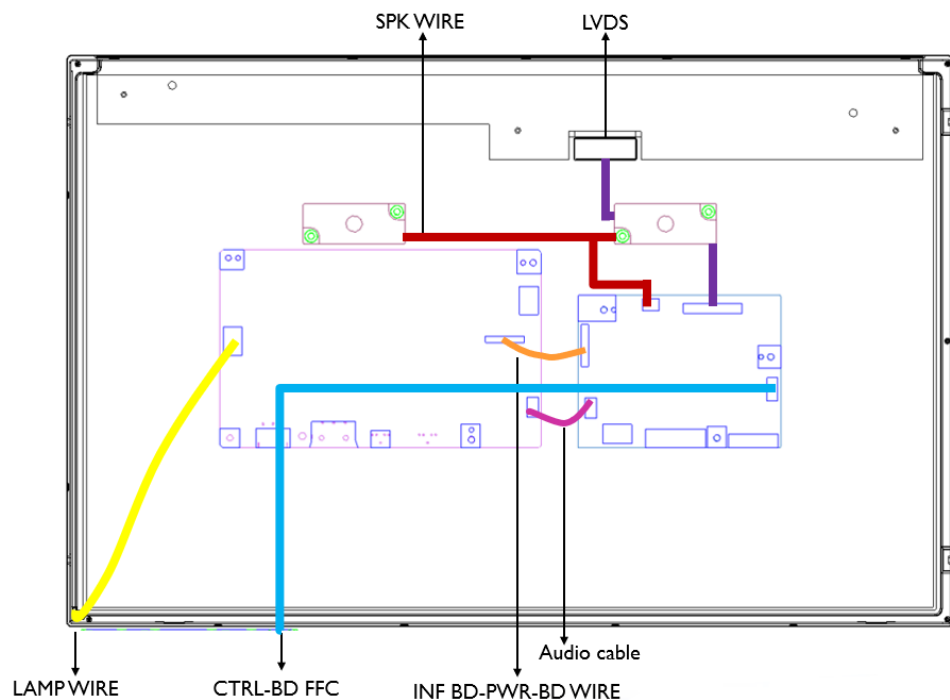

3. SKU with USB, without HDMI/DP

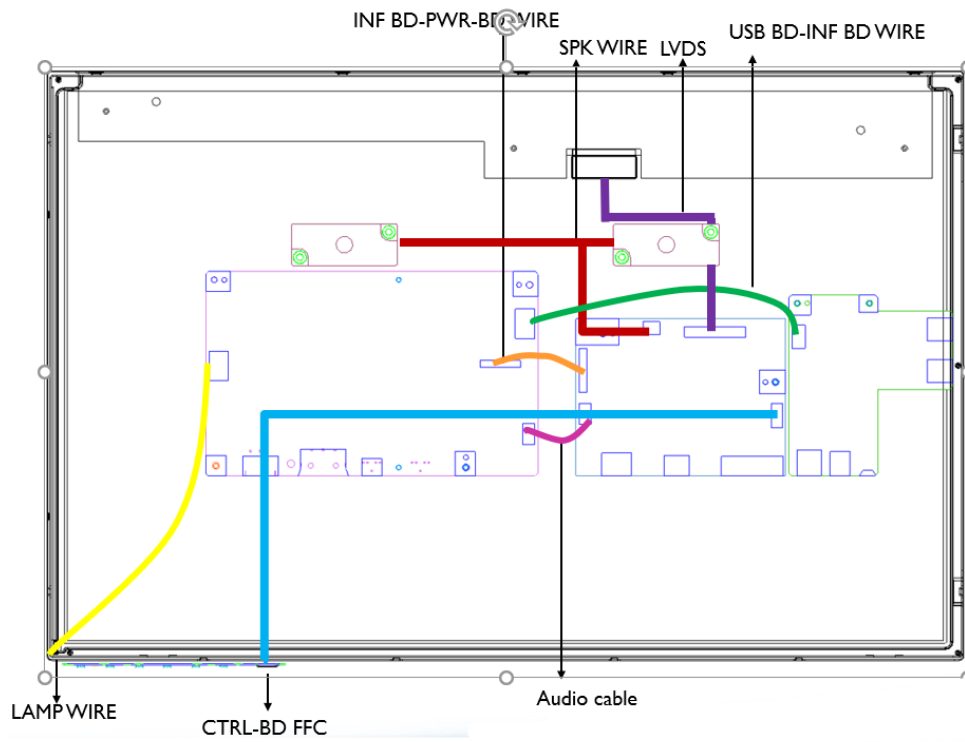

4. SKU with USB, with HDMI/DP

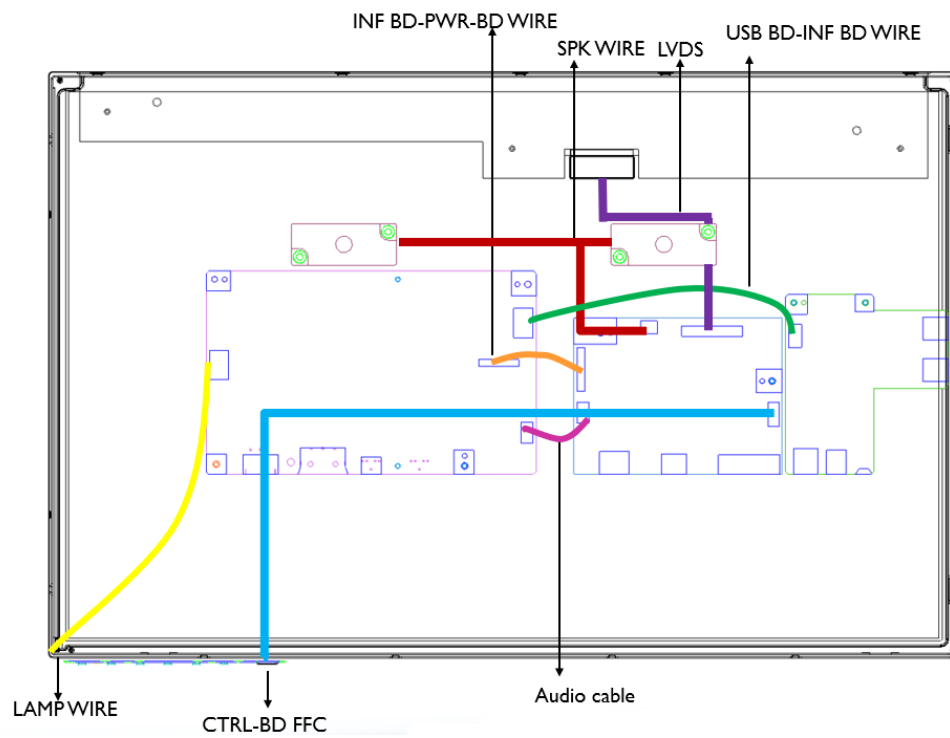

3. Mechanical Instruction

Tools Required

List the type and size of the tools that would typically can be used to disassemble the product to a point

where components and materials requiring selective treatment can be removed.

Tool Description:

- working table
- Screw-driver: Philips-head screwdriver, Hex-head screwdriver
- Knife
- glove
- cleaning cloth
- ESD protection

4. Disassembly and Assembly SOP

V226HQL

4.1 Disassembly Procedures

Preparation before disassemble

1. Clean the room for disassemble
2. Identify the area for monitor
3. Check the position that the monitors be placed and the quantity of the monitor ;prepare the area for material flow; according to the actual condition plan the disassemble layout
4. Prepare the implement, equipment, materials as bellow:
 - 1) working table
 - 2) Screw-driver: Philips-head screwdriver, Hex-head screwdriver
 - 3) knife
 - 4) glove
 - 5) cleaning cloth
 - 6) ESD protection



After unplugging the power cord, the power board still have power energe. Please pay attention when disassembling/assembling Power BD.

S1

Disassemble the RC(Rear Case), stand and base

Before Disassembling & Assembling, monitor need to be put on the sponge and the Insulation glove must be wore during the process.

Disassemble Stand and Base from the RC(Rear Case). Unlock RC screws. Disassemble RC from monitor.

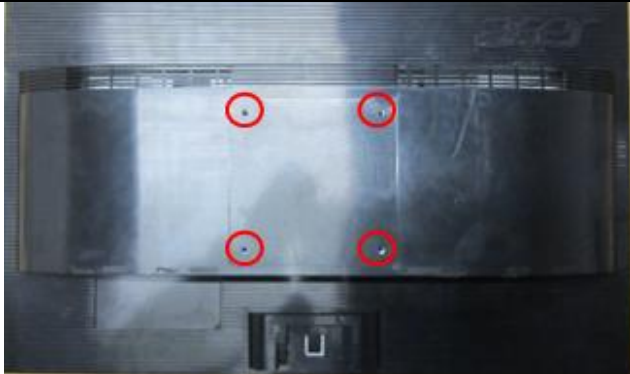

S2

Disassemble SHD

Tear down AL-Tape off SHD(Shielding) as picture 1.



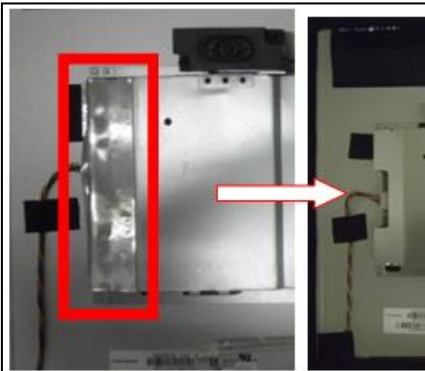

Unlock the Hexagonal screws and the DP screw as picture 2.

PICTURE 1

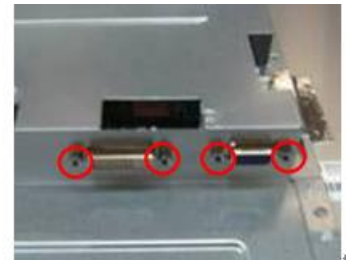

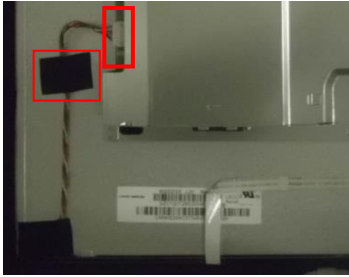
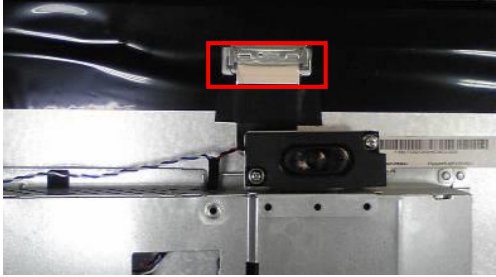
PICTURE 2

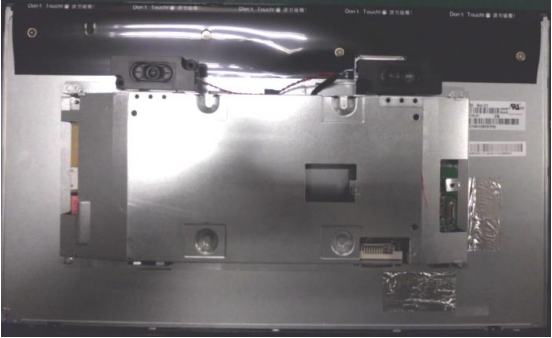
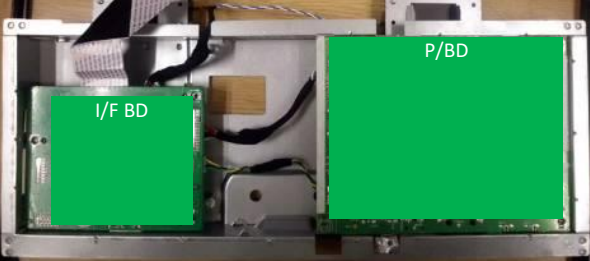
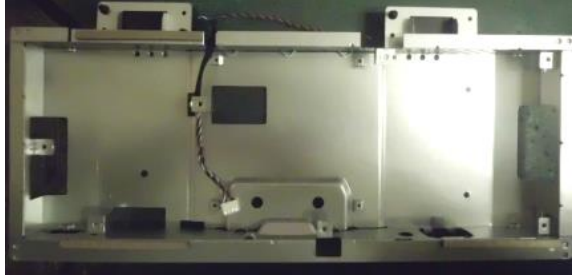

<p>S3 Disassemble the cables</p>	<p>Tear off the tape on the lamp wire and extract the lamp wire from the P/BD(Power Board) as picture 1. Tear off the tape, pull out the FFC as picture 2. Pull the CTRL BD-FFC out of the PCBA and the CTRL BD, tear off the tape and disassemble the CTRL BD-FFC</p>
<p>PICTURE 1</p> 	<p>PICTURE 2</p>  <p>PICTURE 3</p> 
<p>S4 Disassemble the MF from panel</p>	<p>Tear off the tapes, take out the Panel and the CTRL BD of the MF</p>
	
<p>S5 Disassemble I/F BD, P/BD and SPK from SHD..</p>	<p>Disassembled the Mylar and unlock all screws. Disassemble the I/F BD from the SHD and extract the P/BD wire. Extract the FFC LVDS from the I/F BD. Disassemble the P/BD from the SHD. Disassemble SPK.</p>
<p>PICTURE 1</p> 	<p>PICTURE 2</p> 
	<p>NOTE: Circuit boards >10 cm² has been highlighted with the yellow rectangle as above image shows. Please detach the Circuit boards and follow local regulations for disposal.</p>

4.2 Assembly Procedures

Preparation before assemble:

1. Clean the room for work
2. Identify the area for material
3. Prepare the implement, equipment, materials as bellow:
 - 1) working table
 - 2) Screw-driver
 - 3) Knife
 - 4) glove
 - 5) cleaning cloth
 - 6) ESD protection



After unplugging the power cord, the power board still have power energy. Please pay attention when disassembling/assembling Power BD.

S1

Assemble the MAIN board, power board and SPK.

Before Disassembling & Assembling, monitor need to be put on the sponge and the Insulation glove must be wore during the process.

Assemble the SPK to SHD as picture 1.
 Insert the FFC to the I/F as picture 2.
 Insert the DP-Wire to the I/F BD and the P/BD.
 Insert the P/BD-Wire and SPK-Wire to I/F BD,
 Place the I/F BD and the P/BD to SHD and lock all screws as the picture 3.
 Put Mylar on the Power BD as picture 4.

PICTURE 1

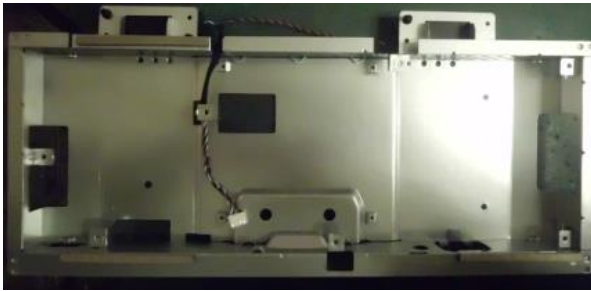

PICTURE 2

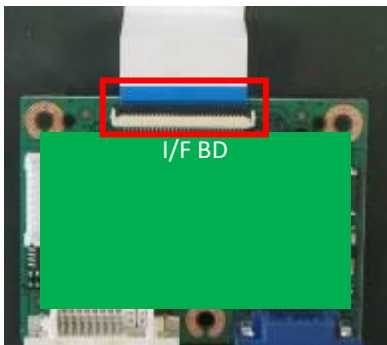

PICTURE 3

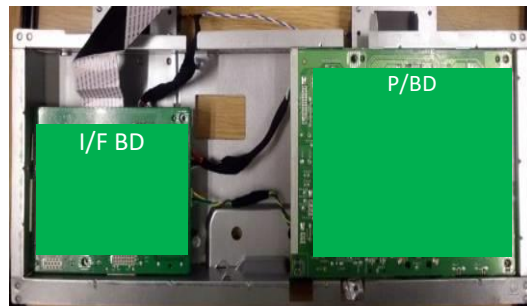

PICTURE 4

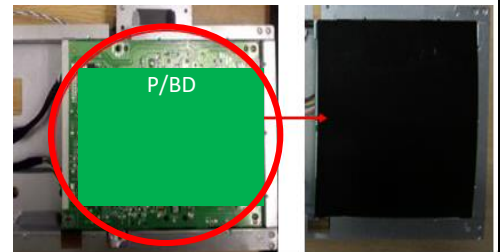
**S2**

Assemble the ASSY TRIM





Insert the C/B-FFC to C/B as circle frame, and insert them into the BZL
 Assemble the panel on the BZL
 Stick Mylar on C/B FFC as square frame and Insert the C/B-FFC to the PCBA as circle frame.

PICTURE 1

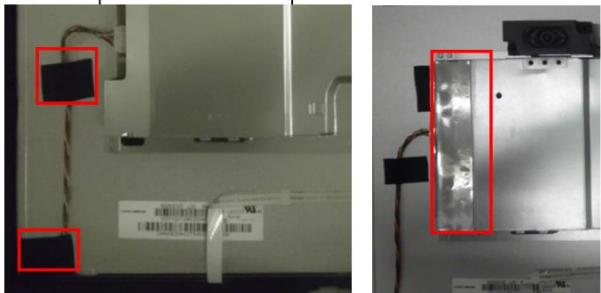
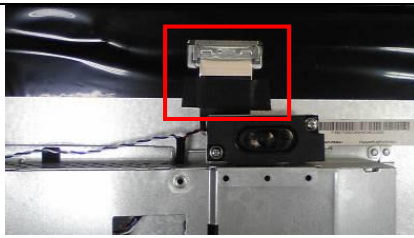
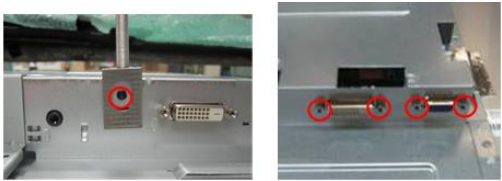
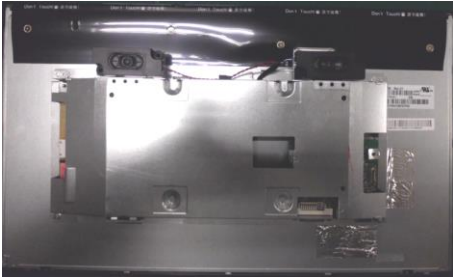

PICTURE 2



<p>S3 Assemble the lamp wire</p>	<p>Insert the big connector of the lamp wire to the P/BD . Stick 2 tape to fasten the lamp wire and one AL-Tape on SHD as the picture.</p>
	
<p>S4 Assemble LVDS cable</p>	<p>Insert the LVDS cable to the Panel and stick one tape on LVDS cable.</p>
	
<p>S5 Assemble SHD</p>	<p>Lock the Hexagonal screws and DP screw as picture 1. Use jig to put the SHD in correct position on Panel. Take off the jig and stick two AL tapes as picture 2.</p>
<p>PICTURE 1</p> 	<p>PICTURE 2</p> 
<p>S6 Assemble RC, stand and base</p>	<p>Assemble the RC with screw. Assembly the Stand and the Base to Monitor</p>
	
	<p>NOTE: Circuit boards >10 cm² has been highlighted with the yellow rectangle as above image shows. Please detach the Circuit boards and follow local regulations for disposal.</p>

5. Troubleshooting

TROUBLESHOOTING

Before sending your LCD monitor for servicing, please check the trouble-shooting list below to see if you can self-diagnose the problem.

(VGA Mode)

Problems	Current Status	Remedy
No Picture	LED ON	<ul style="list-style-type: none"> Using OSD, adjust brightness and contrast to maximum or reset to their default settings.
	LED OFF	<ul style="list-style-type: none"> Check the power switch.
		<ul style="list-style-type: none"> Check if AC power cord is properly connected to the monitor.
	LED displays amber color	<ul style="list-style-type: none"> Check if video signal cable is properly connected at the back of monitor.
<ul style="list-style-type: none"> Check if the power of computer system is ON. 		
Abnormal Picture	Unstable Picture	<ul style="list-style-type: none"> Check if the specification of graphics adapter and monitor is in compliance which may be causing the input signal frequency mismatch.
	Display is missing, center shift, or too small or too large in display size	<ul style="list-style-type: none"> Using OSD, adjust RESOLUTION, CLOCK, CLOCK-PHASE, H-POSITION and V-POSITION with non-standard signals. Using OSD, in case of missing full-screen image, please select other resolution or other vertical refresh timing. Using OSD, in case of missing full-screen image, please select other resolution or other vertical refresh timing. Wait for a few seconds after adjusting the size of the image before changing or disconnecting the signal cable or powering OFF the monitor.
Abnormal Sound (Only Audio-Input model) (Optional)	No sound, or sound level is too low	<ul style="list-style-type: none"> Check the audio cable with the host PC is connected.
		<ul style="list-style-type: none"> Check if the volume setup of the host PC is in minimum position and try to raise the volume level.

(HDMI/DP Mode)





Problems	Current Status	Remedy
No Picture	LED ON	<ul style="list-style-type: none"> Using OSD, adjust brightness and contrast to maximum or reset to their default settings.
	LED OFF	<ul style="list-style-type: none"> Check the power switch.
		<ul style="list-style-type: none"> Check if AC power cord is properly connected to the monitor.
	LED displays amber color	<ul style="list-style-type: none"> Check if video signal cable is properly connected at the back of monitor.
<ul style="list-style-type: none"> Check if the power of computer system is ON. 		
Abnormal Sound (Only Audio-Input model) (Optional)	No sound, or sound level is too low	<ul style="list-style-type: none"> Check the audio cable with the host PC is connected.
		<ul style="list-style-type: none"> Check if the volume setup of the host PC is in minimum position and try to raise the volume level.

6. FRU List

This chapter gives you the FRU (Field Replaceable Unit) listing in global configurations of ACER V226HQL. Refer to this chapter whenever ordering for parts to repair or for RMA (Return Merchandise Authorization).

Please note that WHEN ORDERING FRU PARTS, you should check the most up-to-date information available on your regional web or channel. For whatever reasons a part number change is made, it will not be noted on the printed Service Guide. For AUTHORIZED SERVICE PROVIDERS, your office may have a DIFFERENT part number code from those given in the FRU list of this printed Service Guide. You MUST use the local FRU list provided by your regional office to order FRU parts for repair and service of customer machines

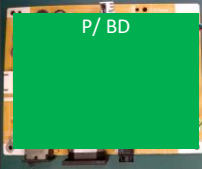
NOTE: To scrap or to return the defective parts, you should follow the local government ordinance or regulations on how to dispose it properly, or follow the rules set by your regional office on how to return it.

Category	ACER DESCRIPTION	Description	PART NO.
LCD			
	LED LCD Panel AUO 21.5"W FHD None Glare T215HVN01.0 00-S03 LF 250nit 5ms 3000:1 HyBrid	LCDM21.5W T215HVN01.0 Z/G AUO	KL.21505.010
BOARD			
	MAIN BD DP+S AUO	PCBA IF BD MI DP+S AU V226HQL	55.LY7M3.001
	POWER BD	PCBA SPS BD MI DP+S V226HQL	55.LY7M3.003
	CONTROL BOARD	PCBA CTRL BD SMD V226HQL	55.LY7M3.002